

TEST REPORT



CTK Co., Ltd.

5 Dongbu-ro 221beon-gil, Cheoin-gu, Yongin-si,
Gyeonggi-do, Republic of Korea
Tel: +82-31-339-9970
Fax: +82-31-624-9501

REPORT No.:
CTK-2025-01521
Page (1) / (14) pages

1. Applicant

- Name : Hanwha Vision Co., Ltd.
- Address : 6 Pangyo-ro 319Beon-gil, Bundang-gu, Seongnam-si,
Gyeonggi-do, 13488 Republic of Korea
- Date of Receipt : Apr. 16, 2025

2. Manufacturer

- Name : Hanwha Vision Co., Ltd.

3. Use of Report :

For submission to customer

4. Test sample / Model :

Network Thermal Camera / TNO-C3080T

5. Date(s) of test :

May. 26, 2025 ~ May. 27, 2025

6. Test Standard (Method) used :

IEC 60529:1989 +A1:1999+A2:2013

7. Testing Environment :

Temperature: (25 ±10) °C, Humidity: (50 ±25) % R.H.

Pressure: (96 ±10) kPa

8. Test Results :

Refer to the test results

9. Location of Test :

Permanent Testing Lab On Site Testing
(113, Yejik-ro, Cheoin-gu, Yongin-si, Gyeonggi-do, 449-100,
Republic of Korea)

The results shown in this test report refer only to the sample(s) tested unless otherwise stated. This report cannot be reproduced or copied without the written consent of CTK.

Approval	Tested by	Technical Manager
	Name: HyungUk Jeon (Signature) 	Name: HoHyun Lee (Signature) 

Remark. This report is not related to KOLAS accreditation and relevant regulation.

Jun. 12, 2025

CTK Co., Ltd.



**CTK Co., Ltd.**

5 Dongbu-ro 221beon-gil, Cheoin-gu, Yongin-si,
Gyeonggi-do, Republic of Korea
Tel: +82-31-339-9970
Fax: +82-31-624-9501

REPORT No.:
CTK-2025-01521
Page (2) / (14) pages

Table of Contents

1. Testing laboratory	3
1.1 Testing laboratory information	3
1.2 Testing laboratory accreditation status	3
2. Product description and equipment information	4
2.1 Product description	4
2.2 Equipment information	4
2.3 Pre-test product images	5
2.4 Testing equipment images	6
2.5 Product appearance	7
3. Degrees of protection provided by enclosures (IP code)	8
3.1 Test date and environmental conditions	8
3.2 Test conditions and methods	8
3.3 Testing images	10
3.4 Test result	12
3.5 Post-test product images	13

**CTK Co., Ltd.**

5 Dongbu-ro 221beon-gil, Cheoin-gu, Yongin-si,
Gyeonggi-do, Republic of Korea
Tel: +82-31-339-9970
Fax: +82-31-624-9501

REPORT No.:
CTK-2025-01521
Page (3) / (14) pages

1. Testing laboratory

1.1 Testing laboratory information

Lab. Name	CTK Co., Ltd.
Representative	Young Joseph Seungwon
Address	5 Dongbu-ro 221beon-gil, Cheoin-gu, Yongin-si, Gyeonggi-do, Republic of Korea
Tel.	+82-31-339-9970
Fax.	+82-31-624-9501
E-Mail	all.youngjin@element.com
Website	www.elementkorea.kr

1.2 Testing laboratory accreditation status

Country	Classification	Accreditation Number	Logo
International	KOLAS	TESTING NO. KT119	

**CTK Co., Ltd.**

5 Dongbu-ro 221beon-gil, Cheoin-gu, Yongin-si,
Gyeonggi-do, Republic of Korea
Tel: +82-31-339-9970
Fax: +82-31-624-9501

REPORT No.:
CTK-2025-01521
Page (4) / (14) pages

2. Product description and equipment information

2.1 Product description

Product Name	Model Name	Quantity	Comment
Network Thermal Camera	TNO-C3080T	1 EA	-

2.1 Model description

Basic Model	TNO-C3080T
Series model	TNO-C3082T,TNO-C3060T,TNO-C3062T
Model differences	TNO-C3082T: Basic model and SW difference TNO-C3060T: Basic model and Fixed Lens difference TNO-C3062T: basic model and Fixed Lens and SW differences

2.2 Equipment information

Testing equipment	Model Name	Manufacturer	Manufacturing Number	Next Cal. Date
Stop Watch	NONE	Casio	612Q01R-1	Jan. 23, 2026
Push Pull Gage	FB30K	Imada	83805	Jan. 16, 2026
Test Rod Probe Ø1.0	TRP-02	ED&D	S1-J15	May. 16, 2027
Dust Chamber	NONE	JFM	S5-IP02	Feb. 14, 2026
Water flow meter with IPX6	M-25	LZT	1903	Feb. 17, 2026
Hose Nozzle (12.5 mm)	IPX6	Kingpo	S5-IP07	-
Steel measuring meter	5.5 m	KOMELON	225851	Jan. 16, 2026



CTK Co., Ltd.

5 Dongbu-ro 221beon-gil, Cheoin-gu, Yongin-si,
Gyeonggi-do, Republic of Korea
Tel: +82-31-339-9970
Fax: +82-31-624-9501

REPORT No.:
CTK-2025-01521
Page (5) / (14) pages

2.3 Pre-test product images

2.3.1 Test sample



Top



Bottom



Front



Rear



Left side



Right side



CTK Co., Ltd.

5 Dongbu-ro 221beon-gil, Cheoin-gu, Yongin-si,
Gyeonggi-do, Republic of Korea
Tel: +82-31-339-9970
Fax: +82-31-624-9501

REPORT No.:
CTK-2025-01521
Page (6) / (14) pages

2.4 Testing equipment images

2.4.1 Test equipment



Push Pull Gage



Test Rod Probe $\varnothing 1.0$



Dust Chamber



Water flow meter with IPX6



Hose Nozzle (12.5 mm)



Steel measuring meter



CTK Co., Ltd.

5 Dongbu-ro 221beon-gil, Cheoin-gu, Yongin-si,
Gyeonggi-do, Republic of Korea
Tel: +82-31-339-9970
Fax: +82-31-624-9501

REPORT No.:
CTK-2025-01521
Page (7) / (14) pages

2.5 Product appearance

Enclosure dimensions [unit : mm]

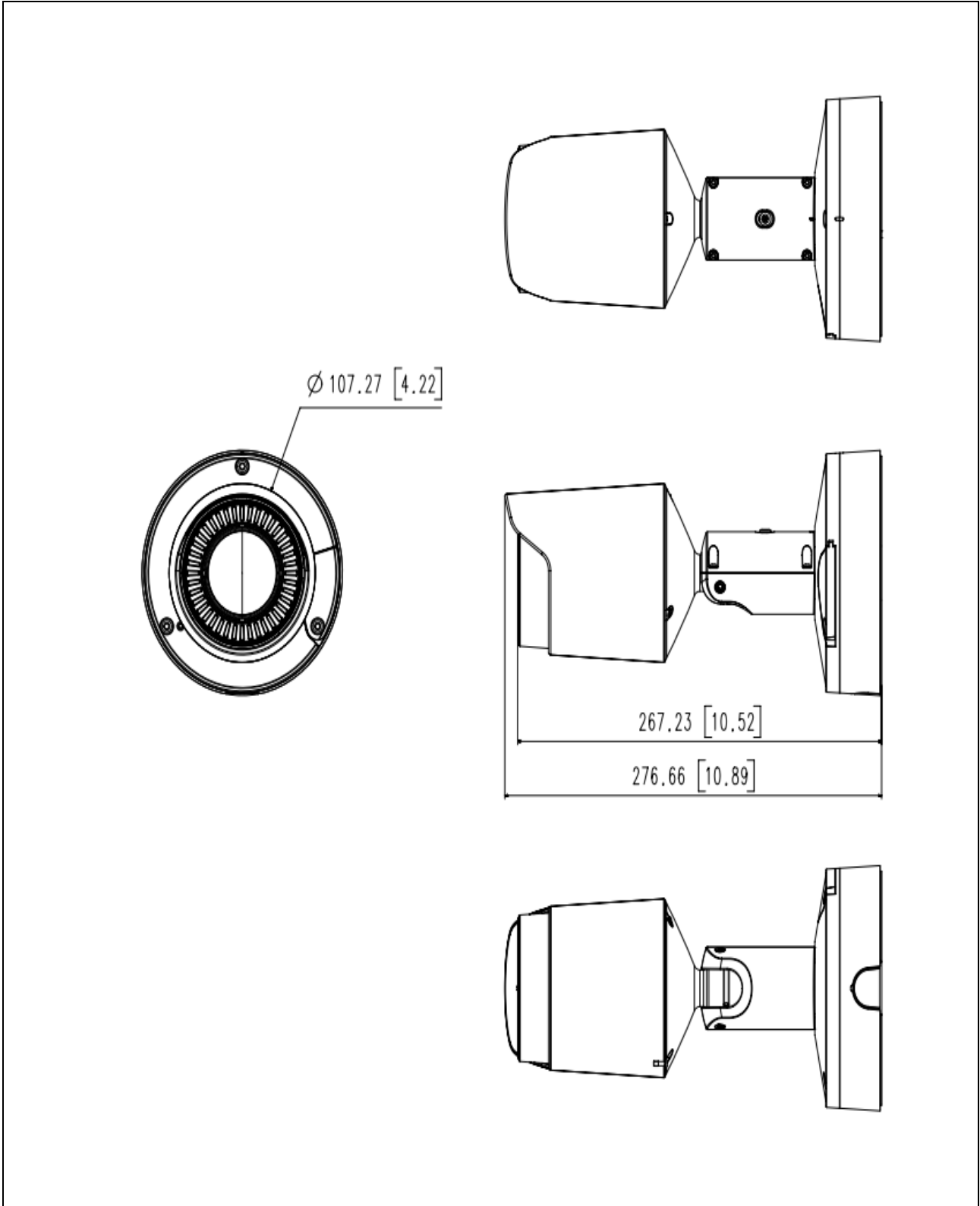

**CTK Co., Ltd.**

5 Dongbu-ro 221beon-gil, Cheoin-gu, Yongin-si,
Gyeonggi-do, Republic of Korea
Tel: +82-31-339-9970
Fax: +82-31-624-9501

REPORT No.:
CTK-2025-01521
Page (8) / (14) pages

3. Degrees of protection provided by enclosures (IP code)**3.1 Test date and environmental conditions**

3.1.1 Test date: May. 26, 2025 ~ May. 27, 2025

3.1.2 Measured Environmental Conditions

Item	Temperature (°C)	Humidity (% R.H.)	Pressure (kPa)
Measurement	27.7	66.7	102.2

3.2 Test conditions and methods

3.2.1 Test standard: IEC 60529:1989+A1:1999+A2:2013

3.2.2 Arrangement of the IP code

Code letters (International protection)

First characteristic numeral (numerals 0 to 6, for letter X)

Second characteristic numeral (numerals 0 to 8, for letter X)

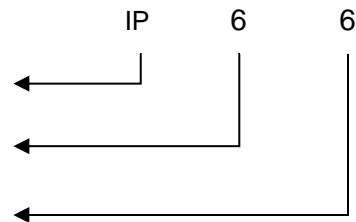

3.2.2.1 Degree of protection against access to hazardous parts indicated by the first characteristic numeral

First characteristic numeral	Degree of protection	Application
6	Protected against access to hazardous parts with a wire. The access probe of 1.0 mmØ, shall not penetrate. Test force: 1 N ± 10 %	<input checked="" type="checkbox"/>

NOTE In the case of the first characteristic numerals 3, 4, 5 and 6, protection against access to hazardous parts is satisfied if adequate clearance is kept. The adequate clearance should be specified by the relevant product committee in accordance with 12.3.

Due to the simultaneous requirement specified in table 2, the definition “shall not penetrate” is given in table 1.



CTK Co., Ltd.

5 Dongbu-ro 221beon-gil, Cheoin-gu, Yongin-si,
Gyeonggi-do, Republic of Korea
Tel: +82-31-339-9970
Fax: +82-31-624-9501

REPORT No.:
CTK-2025-01521
Page (9) / (14) pages

3.2.2.2 Degree of protection against solid foreign objects indicated by the first characteristic numeral

First characteristic numeral	Degree of protection	Application
6	<p>In Dust Testing Equipment, the test sample must have no ingress of dust after testing atmospheric pressure present condition for 8 h.</p> <p>(The talcum powder must pass through a calibrated sieve with a 50 µm wire mesh, spaced at 75 µm intervals in a square pattern. Additionally, the bulk density of the talcum powder should be 2 kg/m³)</p> <p>Products in volume: 2 499.03 cm³ → 2.49 L</p> <p>Target intake volume (Products in volume 80) : 199.92 L</p> <p>Suction volume (Max product in volume 60) ...: 149.94 LPH → 2.49 LPM</p> <p>Actual Suction volume: 2.48 L</p> <p>Suction pressure (Up to 2 kPa): 1.776 kPa</p> <p>Test time (Up to 8 time): 8 hr</p>	☒
<p>¹⁾ The full diameter of the object probe shall not pass through an opening of the enclosure. Due to the simultaneous requirement specified in table 2, the definition “shall not penetrate” is given in table 1.</p>		

3.2.2.3 Degree of protection against water indicated by the second characteristic numeral

Second characteristic numeral	Degrees of protection	Application
6	<p>The product must not be harmed in any direction even strong jet water.</p> <p>Water jet hose nozzle Fig.6, Nozzle 12.5 mm diameter</p> <p>Water flow rate: 100 l/min ± 5 % : 100 LPM</p> <p>Distance: 2.5 m to 3 m: 3 m</p> <p>Duration of test: 1 min/m² at least 3 min: 3 min</p>	☒



CTK Co., Ltd.

5 Dongbu-ro 221beon-gil, Cheoin-gu, Yongin-si,
Gyeonggi-do, Republic of Korea
Tel: +82-31-339-9970
Fax: +82-31-624-9501

REPORT No.:
CTK-2025-01521
Page (10) / (14) pages

3.3 Testing images

3.3.1 Evidence of test setting (1)



Probe test



Probe test

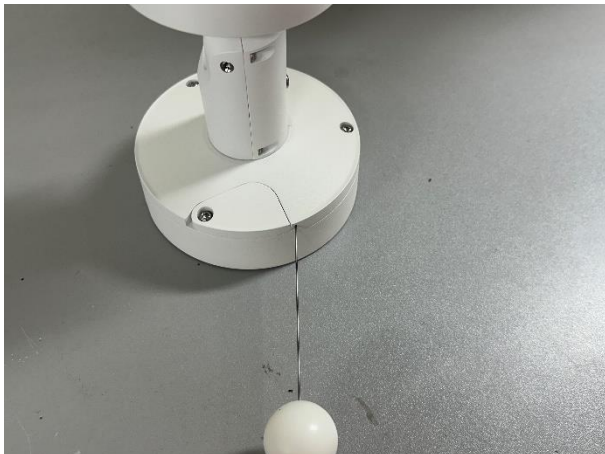

Probe test



Probe test



Probe test



Probe test



CTK Co., Ltd.

5 Dongbu-ro 221beon-gil, Cheoin-gu, Yongin-si,
Gyeonggi-do, Republic of Korea
Tel: +82-31-339-9970
Fax: +82-31-624-9501

REPORT No.:
CTK-2025-01521
Page (11) / (14) pages

3.3.2 Evidence of test setting (2)



Dust test



Dust test



Dust test Monitor

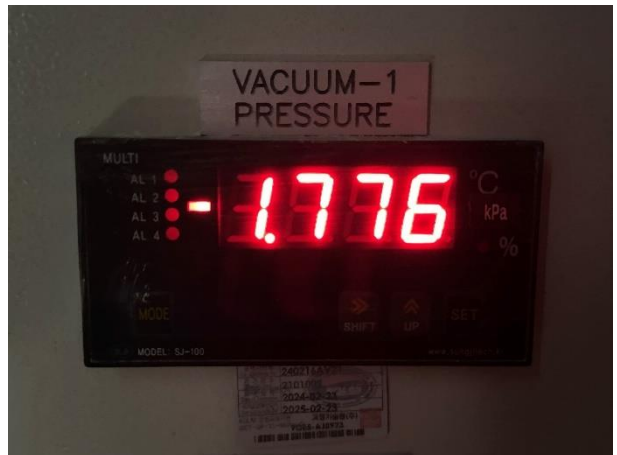

Digital Vacuum Pressure



Water test



Water test

**CTK Co., Ltd.**

5 Dongbu-ro 221beon-gil, Cheoin-gu, Yongin-si,
Gyeonggi-do, Republic of Korea
Tel: +82-31-339-9970
Fax: +82-31-624-9501

REPORT No.:
CTK-2025-01521
Page (12) / (14) pages

3.4 Test result

3.4.1 Test result table

IP code	Evaluation Criteria	Test Results	Remark
IP 6X	No ingress of Probe	Normal	-
	No ingress of dust	Normal	-
IP X6	No ingress of water	Normal	-

※ Refer to the product photos after the completion of testing in section 3.5.



CTK Co., Ltd.

5 Dongbu-ro 221beon-gil, Cheoin-gu, Yongin-si,
Gyeonggi-do, Republic of Korea
Tel: +82-31-339-9970
Fax: +82-31-624-9501

REPORT No.:
CTK-2025-01521
Page (13) / (14) pages

3.5 Post-test product images

3.5.1 Product internal images after test [The first characteristic numeral test]

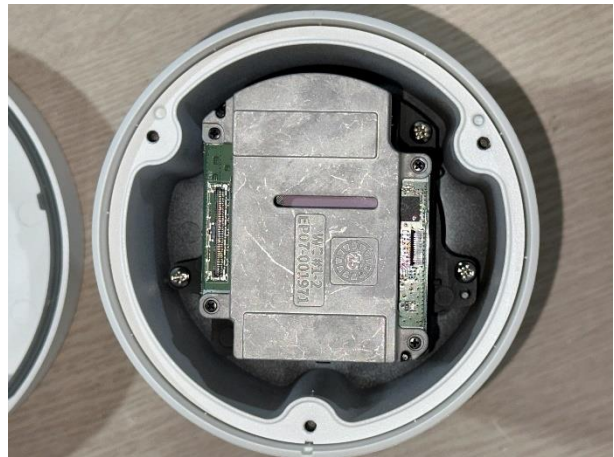
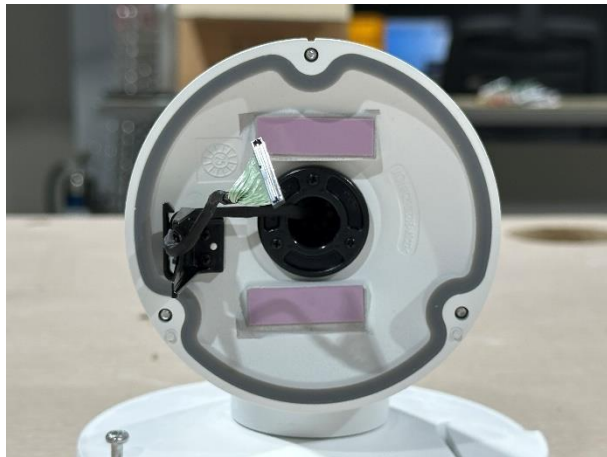
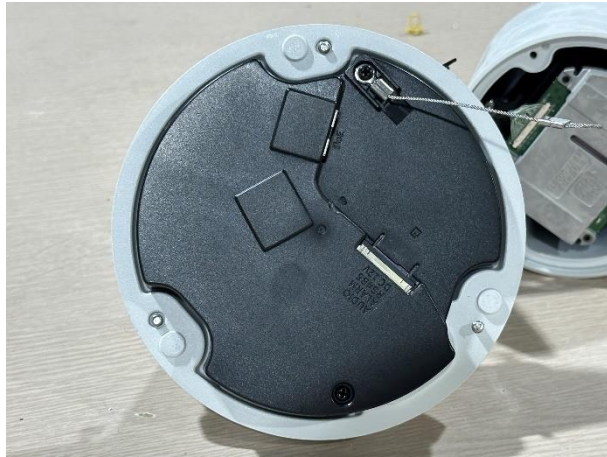



CTK Co., Ltd.

5 Dongbu-ro 221beon-gil, Cheoin-gu, Yongin-si,
Gyeonggi-do, Republic of Korea
Tel: +82-31-339-9970
Fax: +82-31-624-9501

REPORT No.:
CTK-2025-01521
Page (14) / (14) pages

3.5.2 Product internal images after test [The second characteristic numeral test]

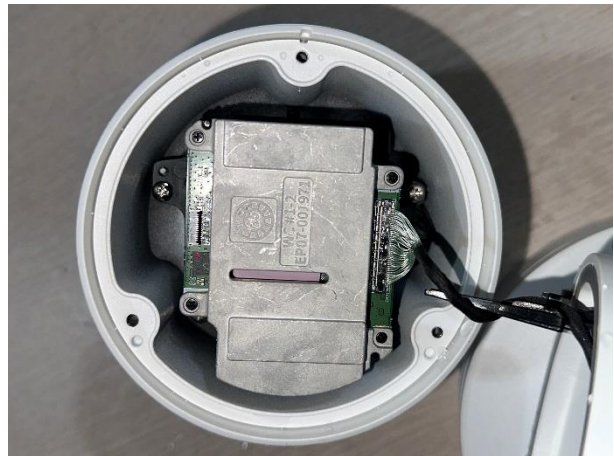
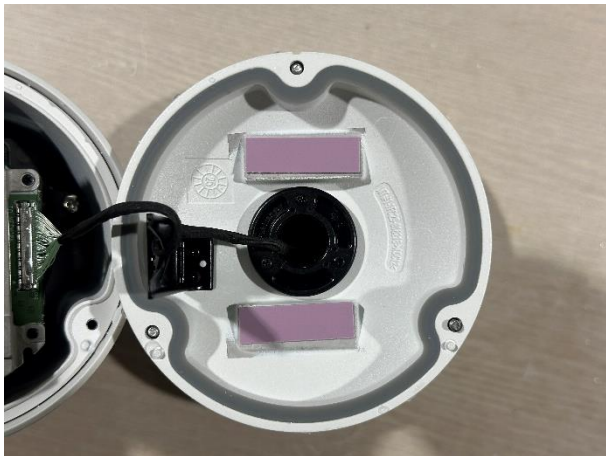

- End -